

Likorall™ 242/243/250



Overhead lifts

Instructions for Use

Likorall 242 S	Prod. no. 3122009-3122010
Likorall 242 ES	Prod. no. 3122005-3122006
Likorall 242 S R2R	Prod. no. 3122011-3122012
Likorall 242 ES R2R	Prod. no. 3122007-3122008
Likorall 243 ES	Prod. no. 3123001-3123002
Likorall 250 ES	Prod. no. 3122501-3122502
Likorall 250 S, IRC	Prod. no. 3124050

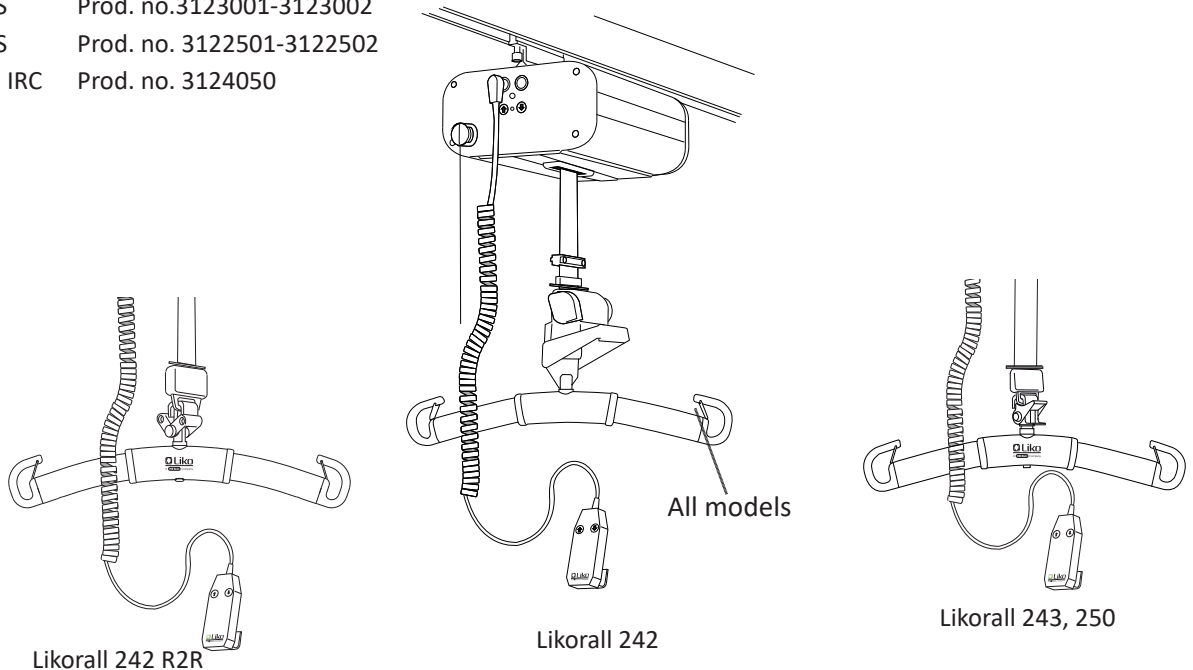

Product Description

Likorall overhead lift is a general-purpose Liko™ lift with the intended use in: health care, intensive care and rehabilitation.

Likorall overhead lift is designed and developed for the complete range of Liko™ fixed installed and free-standing lift systems. A Liko™ lift system is always close at hand and easy to use.

All common lifts and transfers can be performed using Likorall overhead lift, for instance between bed/wheelchair, to/from floor, toilet visits, gait training, and together with stretchers. Likorall R2R (room to room) overhead lift enables the patient to be moved between two rail systems in separate rooms, without connecting rails and without making holes over doors.

Likorall overhead lift with the ES designation is prepared for operation with the wireless HandControl Remote (IR) and in addition, a Transfer Motor can be connected for motor driven movement of Likorall ES overhead lift along the rail. Likorall S, IRC overhead lift is prepared for continuous charging through the railsystem by the Liko™ In-Rail charging system (IRC)

Accessories

A large and complete range of accessories are available for Likorall overhead lift, including many different sling models in several sizes and designs.

In this document, the person being lifted is referred to as the patient, and the person helping is referred to as the caregiver.

IMPORTANT!





















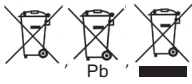



Lifting and transferring a patient always involves a certain level of risk. Read the instructions for use for both the patient lift and lifting accessories before use. It is important to completely understand the contents of the instructions for use. The equipment should only be used by trained personnel. Ensure that the lifting accessories are suitable for the lift used. Exercise care and caution during use. As a caregiver, you are always responsible for the patient's safety. You must be aware of the patient's ability to make it through the lifting situation. If something is unclear, contact the manufacturer or supplier.

Table of Contents

Symbol Description	3
Safety Instructions	4
Definitions	5
Technical Data	5
Measurements	6
EMC Table.....	6
Operation	9
Charging the Batteries	12
Transferring from Room to Room.....	13
Maximum Load.....	14
Recommended Lifting Accessories	14
Simple Troubleshooting.....	16
Recycling Instructions.....	17
Cleaning and Disinfection	18
Inspection and Maintenance	22

Symbol Description

These symbols can be found in this document and/or on the product.

Symbol	Description
	For indoor use only.
	The product has extra protection against electric shock (Insulation Class II).
	Protection level against electric shock Type B.
	Warning. Used were extra care and attention is needed.
	Read instructions for use before use.
	This product complies with EC directives.
IP N ₁ N ₂	Protection level against: ingress of solid objects (N1) and ingress of water (N2).
	Manufacturer.
	Date of manufacture.
	Caution! consult instructions for use.
	Consult instructions for use for more information.
	Battery.
	All batteries in this product must be recycled separately. - Pb underneath the symbol indicate batteries containing lead - Single Black line underneath the symbol indicate this product have been placed on the market after 2005.
	UL Recognized Component Mark for Canada and the United States.
	EFUP, Environmental Friendly Usage Period (years).
	Environmentally-friendly product which can be recycled and reused.
	The Australian Safety/EMC.
	PSE Mark (Japan).
	Product Identifier.
	Serial Number.
	Medical Device.
	Recyclable.
	The safety and essential performance of medical electrical equipment.
	Proof of Product compliance to North American safety standards.
	Non-ionizing electromagnetic radiation.
	Duty cycle for non-continuous operation. The maximum active operation time X% of any given time unit, followed by a deactivation time, Y%. The active operation time shall not exceed the specified time in minutes, T.
	GS1 Data Matrix Barcode that may contain following information (01) Global Trade Item Number (11) Production Date (21) Serial Number

Safety Instructions

Intended Use

This product is not intended to be used by the patient alone. Lifting and transferring a patient shall always be performed with the assistance of at least one caregiver. This product is used as a means to perform the lift but is not in contact with the patient; therefore we do not go into the various patient conditions in this manual. Contact your Hill-Rom representative for support and advice.

⚠ Installation of Likorall overhead lift to carriages shall be made by personnel authorized by Hill-Rom in accordance with the installation instructions and recommendations for the current lift system.

Before use, make sure that:

- the lifting accessory is properly attached to the lift
- the batteries have been charged for at least 8 hours
- you have read the instructions for use for the lift and lifting accessories
- personnel using the lift are informed of the correct operation and use of the lift

Before lifting, always make sure that:

- the lifting accessory is selected appropriately, in terms of type, size, material and design with regard to the patient's needs.
- the lift strap is not twisted or worn and can move in and out of the lift freely
- the lifting accessories are not damaged
- the lifting accessory is correctly and safely applied to the patient in order to prevent injuries
- the lifting accessory is properly attached to the lift
- the lifting accessory hang vertically and can move freely
- the latches are intact; missing or damaged latches must always be replaced
- the sling's strap loops are correctly connected to the sling bar hooks when the sling straps are extended upwards, but before the patient is lifted from the underlying surface.

⚠ Incorrect attachment of sling to slingbar may cause Severe injury to the patient.

⚠ If the Likorall is installed in the S65 carriage with single hook, make sure it is resting securely at the bottom of the hook and is not tilted.

⚠ Never leave a patient unattended during a lifting situation!



Likorall is tested by an accredited testing institute.

⚠ No modification of this product is allowed.

⚠ Portable RF communications equipment (including peripherals such as antenna cables and external antennas) should be used no closer than 30 cm (12 inches) to any part of the lift, including cables specified by the manufacturer. Otherwise, degradation of the performance of this equipment could result.

⚠ Use of the product adjacent to other equipment should be avoided because it could result in improper operation. If such use is necessary, observe and verify that the other equipment is operating normally.

Electromagnetic disturbance may affect the lifting performance of the product. Modification using other parts than original spare parts (cables, etc.) may affect the electromagnetic compatibility of the product. Particular care must be observed when using strong sources of electromagnetic disturbance, such as diathermy, etc, so that diathermy cables are not positioned on or near the lift.



If you have questions, please consult the responsible assistive-device technician or the supplier.

The product may not be used in areas where flammable mixtures may occur, for example in areas where flammable goods are stored.

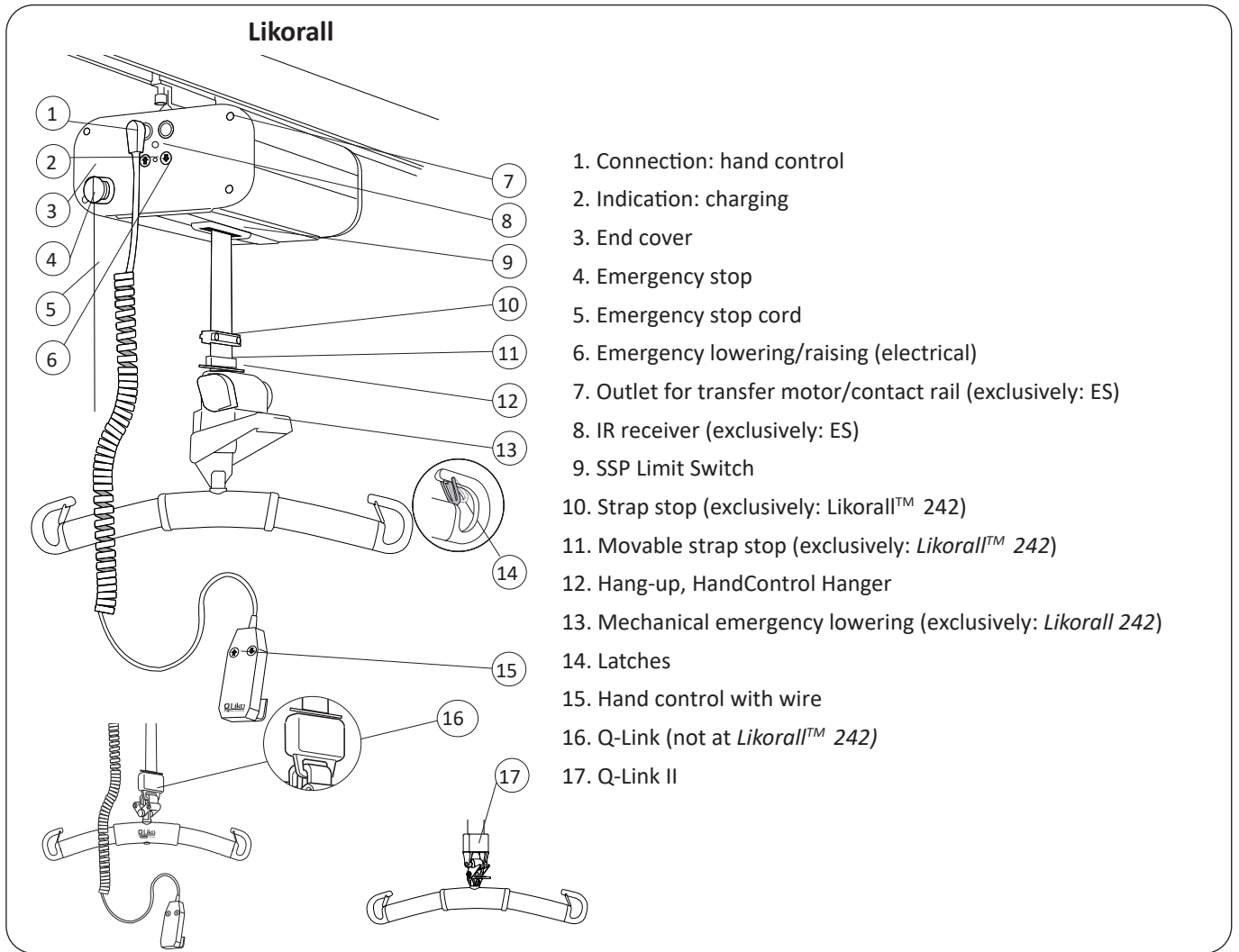
Definitions



Technical Data

Maximum load:	Likorall™ 242: 200 kg (440 lbs) Likorall™ 243: 230 kg (507 lbs) Likorall™ 250: 250 kg (550 lbs)	Emergency lowering device:	Mechanical: Likorall 242 Electrical: Likorall 242 R2R Likorall 243 Likorall 250
Batteries:	2 x 12 V (2.4 Ah - 2.6 Ah). Valve-regulated lead-acid gel-type batteries. New batteries are provided by the supplier.	Intermittent operation:	Int. Op 10/90, active operation max 30 Sec.
Battery charger:	SMP CC-10-43-24; 100-240 V AC, 40-60 Hz, max 600 mA IRC (In-Rail Charging): CH01 FW7218M/24; 100-240 V AC, 50-60 Hz, max 500 mA	Sound level:	49 dB
Lifting speed:	50 mm/s (2 inch./s)	Protection class:	IP 43
Lifting interval:	2050 mm (80.7 inch.) (242 vertically adjustable)	Protection class hand control:	IP 43
Electrical data:	24 V, 12 A	Operating forces of controls:	5 N
Lift motor weight:	Likorall 242 13.0 kg (28.6 lbs) Likorall 242 R2R 13.2 kg (29 lbs) Likorall 243 12.6 kg (27.7 lbs) Likorall 250 12.6 kg (27.7 lbs)	Ambient temperature:	Min. + 10°C - Max. + 50°C (Min. 50° F - Max. 122° F)
			Intended for indoor use.
			Type B, in accordance with the electrical shock protection class.

The Likorall™ overhead lift is equipped with a SFS (Single Fault Safety) safety drum. This patented safety design provides protection against uncontrolled lowering. The lift strap has a tenfold safety.

Measurements

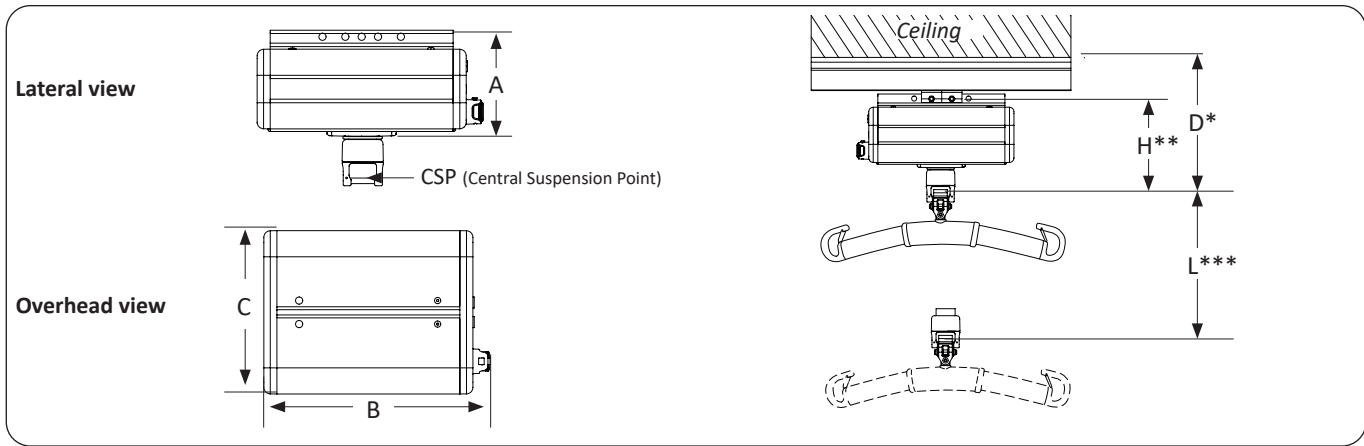

Measurements in mm.

A	B	C	D*	H**		L***
165	340	250	304	221 (models: 242 R2R, 243, 250)		2050
				346 (models: 242)		

Measurements in inch.

A	B	C	D*	H**		L***
6.5	13.4	9.8	12.0	8.7 (models: 242 R2R, 243, 250)		80.7
				13.6 (models: 242)		

* Minimum distance from ceiling to CSP at maximum lifting height with the standard carriage.

** Built-in dimension: the distance between the attachment point for the lift unit on the carriage and the CSP at maximum lifting height.

*** Lifting interval: the distance between maximum lifting height and minimum lifting height measured in CSP.

EMC Table

Guidance and manufacturer's declaration – electromagnetic emissions		
This product is intended for use in the electromagnetic environment specified below. The customer or the user of this product should assure that it is used in such an environment.		
Emissions test	Compliance	Electromagnetic environment - guidance
RF emissions CISPR 11	Group 1	The product uses RF energy only for its internal function Therefore, its RF emissions are very low and are not likely to cause any interference in nearby electronic equipment.
RF emissions CISPR 11	Class B	The product is suitable for use in all establishments other than domestic and those directly connected to the public low-voltage power supply network that supplies buildings used for domestic purposes.
Harmonic emissions IEC 61000-3-2	Class A	
Voltage fluctuations/ flicker emissions IEC 61000-3-3	Complies	

Guidance and manufacturer's declaration – electromagnetic immunity

The product is intended for use in the electromagnetic environment specified below. The customer or the user of this product should assure that it is used in such an environment.

Immunity test	IEC 60601 test level	Compliance level	Electromagnetic environment - guidance
Electrostatic discharge (ESD) IEC 61000-4-2	+/- 6 kV contact +/- 8 kV air	+/- 6 kV contact +/- 8 kV air	
Electrical fast transient / Burst IEC 61000-4-4	+/- 2 kV for power supply lines +/- 1 kV for input/output lines	+/- 2 kV for power supply lines n/a. for input/output lines	Mains power quality should be that of a typical commercial or hospital environment.
Surgew IEC 61000-4-5	+/- 1 kV differential mode +/- 2 kV common mode	+/- 1 kV differential mode n/a. for common mode	Mains power quality should be that of a typical commercial or hospital environment.
Voltage dips, short interruptions and voltage variations on power supply input lines IEC 61000-4-11	<5 % U_T (>95 % dip in U_T) for 0,5 cycle 40 % U_T (60 % dip in U_T) for 5 cycles 70 % U_T (30 % dip in U_T) for 25 cycles <5 % U_T (>95 % dip in U_T) for 5 sec		
Power frequency (50/60 Hz) magnetic field IEC 61000-4-8	3 A/m	3 A/m	Power frequency magnetic fields should be at levels characteristic of a typical location in a typical commercial or hospital environment
Conducted RF IEC 61000-4-6	3 Vrms 150 kHz to 80 MHz	3 Vrms 150 kHz to 80 MHz	
Radiated RF IEC 61000-4-3	10 V/m 80MHz to 2,5GHz	10 V/m 80MHz to 2,5GHz	

NOTE U_T is the a.c. mains voltage prior to application of the test level.

Guidance and manufacturer's declaration – electromagnetic immunity

The product is intended for use in the electromagnetic environment specified below. The customer or the user of this product should assure that it is used in such an environment.

Immunity test	IEC 60601 test level	Compliance level	Electromagnetic environment - guidance
Conducted RF IEC 61000-4-6	3 Vrms 150 kHz to 80 MHz		<p>Portable and mobile RF communications equipment should be used no closer to any part of the product, including cables, than the recommended separation distance calculated from the equation applicable to the frequency of the transmitter.</p> <p>Recommended separation distance</p> $d = 0,35\sqrt{P}$
Radiated RF IEC 61000-4-3	10 V/m 80MHz to 2,5GHz		$d = 0,29\sqrt{P} \quad 80 \text{ MHz to } 800 \text{ MHz}$ $d = 0,58\sqrt{P} \quad 800 \text{ MHz to } 2,5 \text{ GHz}$ <p>where P is the maximum output power rating of the transmitter in watts (W) according to the transmitter manufacturer and d is the recommended separation distance in meters (m).</p> <p>Field strengths from fixed RF transmitters, as determined by an electromagnetic site survey,^a should be less than the compliance level in each frequency range.^b</p> <p>Interference may occur in the vicinity of equipment marked with the following symbol.</p> 

NOTE 1 At 80MHz and 800MHz, the higher frequency range applies.

NOTE 2 These guidelines may not apply in all situations. Electromagnetic propagation is affected by absorption and reflected from structures, objects and people.

^a Field strengths from fixed transmitters, such as base stations for radio (cellular/cordless) telephones and land mobile radios, amateur radio, AM and FM radio broadcast and TV broadcast cannot be predicted theoretically with accuracy. To assess the electromagnetic environment due to fixed RF transmitters, an electromagnetic site survey should be considered. If the measured field strength in the location in which the product is used exceeds the applicable RF compliance level above, the product should be observed to verify normal operation. If abnormal performance is observed, additional measures may be necessary, such as reorienting or relocating the product.

^b Over the frequency range 150 kHz to 80 MHz, field strengths should be less than 10 V/m.

Operation

Button functions:

- Up arrow, Down arrow: Lifting movement: Up/Down
- Left arrow, Right arrow: Movement direction: Transfer motor
- Person icon, Person icon: Control: Switch system

Fits Likorall:	All	(ES)	(ES)	(ES)	HandControl Remote IR (ES)

Hand Control Likorall™ Overhead Lift

Likorall™ overhead lift is operated with a light push on the buttons of the hand control. The arrow directions should be the same as the direction shown in the illustration. The movement ceases when the button is released. For the Likorall™ ES overhead lift, there is a number of hand controls to choose from, depending on how the lift and rail system are equipped, and an IR hand control for wireless operation.

If needed, the lifting motion can also be controlled without hand control via the buttons and respectively, on the end cover of the lift, see illustration below.

Activate: Pull the red emergency stop cord.

Reset: Turn the button in the direction of the arrows.

Emergency stop

For emergency stop: pull the red emergency stop cord.

To reset: turn the button in the direction of the arrows.

The red cord on the lift motor's end cover is intended for use if an emergency situation occurs.

Q-Link II or Q-Link

Quick Release Hook

Lifting accessory with quick-release hook (Likorall: 242 R2R, 243 ES, 250 ES)

Push down the catch and connect the quick-release hook to the Q-Link II or Q-Link. Release and check that the catch locks in order to prevent involuntary unhooking from the Q-Link II or Q-Link. Read more about the Liko™ Quick-release Hook system in chapter "Recommended Lifting Accessories".

⚠ Before lifting check that the Quick-release Hook is correctly attached to the Q-Link II or Q-Link, see illustration above.



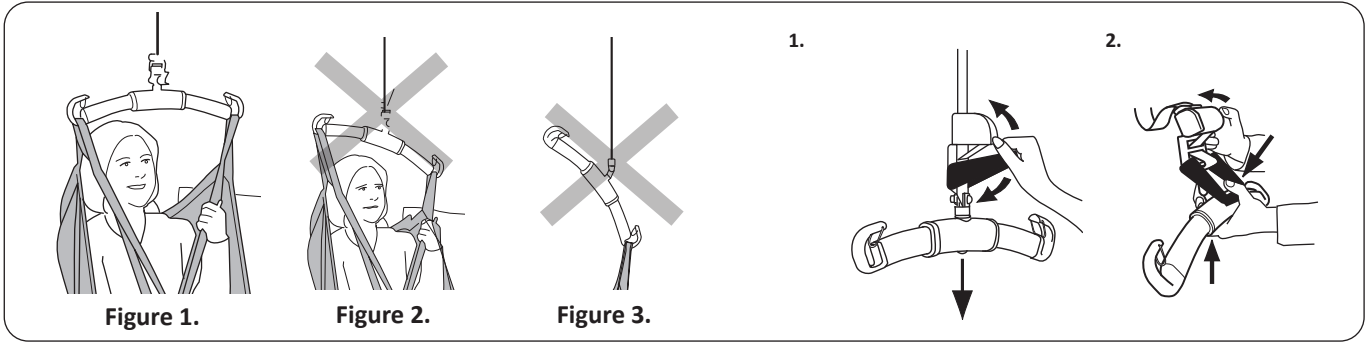

Figure 1.

Figure 2.

Figure 3.

Lift correctly!

Before each lift, make sure that:

- the Sling loops at opposite sides of the Sling are at the same height
- all the Sling loops are fastened securely in to the Slingbar hooks
- the Slingbar is level during the lift, see Figure 1.

⚠ If Slingbar is not level (see Figure 2) or if the sling loop(s) is(are) wrongly attached to the slingbar (see Figure 3) lower the user to a firm surface and adjust according to the Instructions for use of Sling in use.

⚠ An improper lift can be uncomfortable for the user and cause damage to the lift equipment! (see Figure 2 and figure 3).

Mechanical emergency lowering (Likorall™ 242 S/ ES)

- 1) Move the emergency lowering handle up and down until the patient has been lowered and the lift strap is completely slack. Always ensure that the emergency lowering is made to a bed, wheelchair or other suitable location.
- 2) After mechanical emergency lowering has been performed, resetting/adjustment of the lifting height is required:
 - Lower the sling bar so that the lift strap is completely slack.
 - Hold down the emergency lowering handle halfway. Simultaneously, tighten the lift strap by turning the black wheel counter clockwise with the other hand. Repeat until the desired height has been achieved.

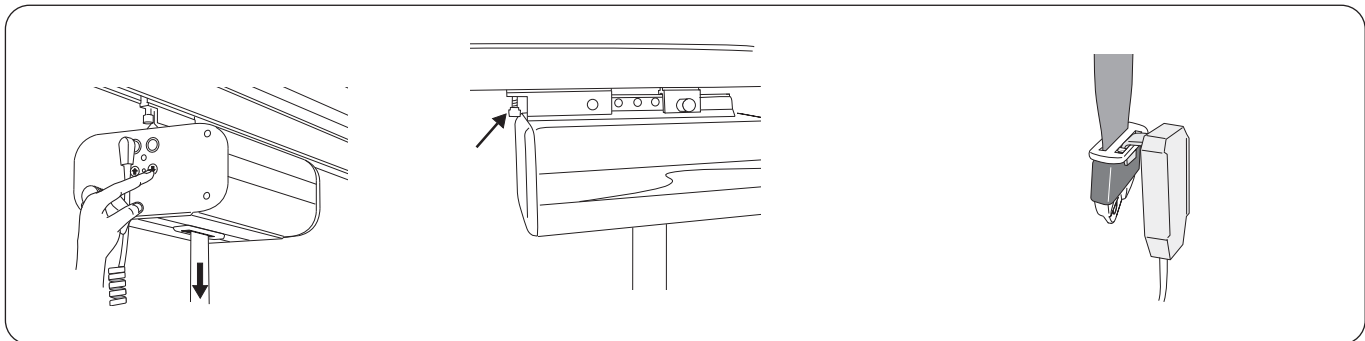

Electrical emergency lowering

Emergency lower by pushing in (⬇) the button on the end cover of the lift. Always ensure that the emergency lowering is made to a bed, wheelchair or other suitable location.

Carriages with adjustable friction brake

The amount of drag along the rail can be adjusted on carriages equipped with a friction brake. Turn the brake clockwise for increased resistance and counter clockwise to reduce resistance.

The following carriages have a friction brake: prod. no. 3126011 and 3126015.

Hang-up HandControl Hanger

When not in use, the hand control can be hung on the Hang-up Hand control hanger.



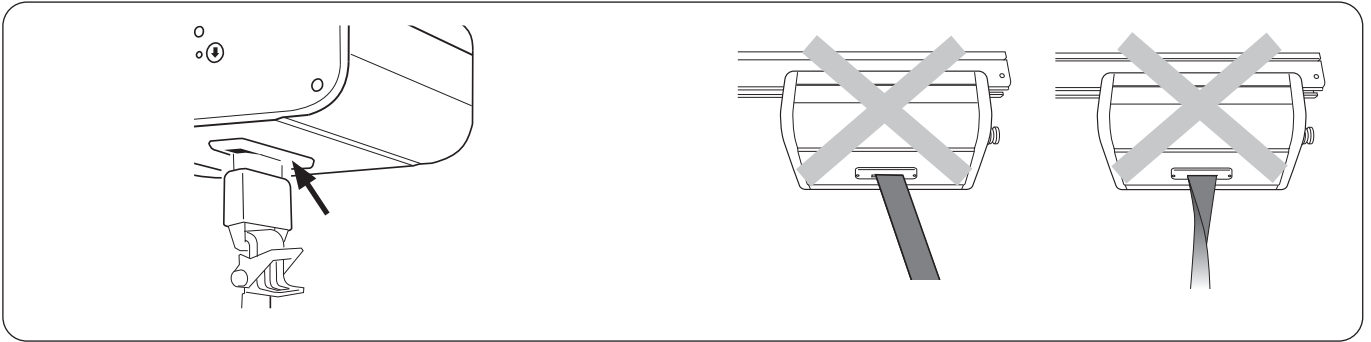

SSP Limit Switch

The lifting motion is stopped electrically with a light touch on the SSP Limit Switch. If the strap stops, Q-Link, or Q-Link II touch the SSP limit switch; or if the lift strap is subjected to harmful strain, for example, if it is pulled sideways or folded over during the lifting motion. If the SSP Limit Switch is activated so that the lifting motion stops, the lift can once again be operated after the lift strap is straight again (a short delay in the lifting motion is normal in these cases). The SSP Limit Switch protects the lift motor from mechanical strain and it also prevents squeeze injuries.

⚠️ Ensure that the lift strap is kept straight and stretched when it runs in and out of the lift motor.

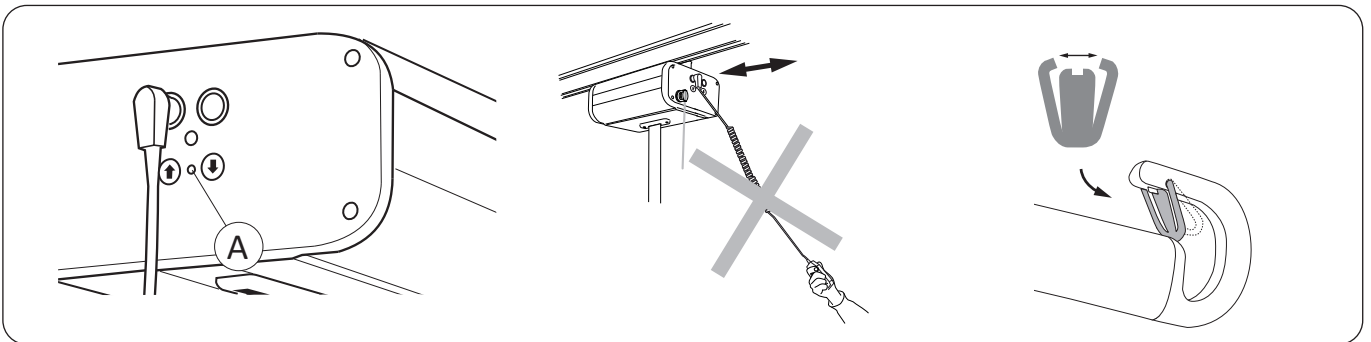

Indication: charging

Likorall™ overhead lift indicates in two ways that the battery needs charging:

- Buzzer: sounds when lifting
- LED, (A) : flashes (red) when lifting

When either of these signals sounds or illuminates, the lift should be charged as soon as possible. See Charging the batteries, page 12.

⚠️ Never move the lift by pulling the hand control!

Installation of Latches

After installation, check that the latch locks and runs freely in the sling bar hook

Charging the Batteries

In order to ensure maximum battery life, it is important to charge the batteries regularly. We recommend that you charge the batteries after use or every night. Full charge is achieved after max. 8 hours. Fully charged batteries will last for approximately 60 lift cycles.

NOTE! If the lift will not be used for a longer period of time, a charging system should be activated to allow the battery to charge or the emergency stop button should be pressed in order to prevent the battery from discharging.

⚠️ Likoall™ overhead lift has several charging systems, these systems must never be activated parallelly.

Charging via hand control

1. Place the hand control in the charger's socket.
2. Connect the charger to a 100-240 V AC electric socket.
3. A green LED illuminates to indicate that the charger is connected to the electrical grid.
4. The charging starts automatically, and a yellow LED indicates that the batteries are charging.
5. When the battery is fully charged, the charger shuts off automatically and the yellow LED turns off.



Read instructions for use before use.



Battery is charging when yellow LED is lit.



AC is connected when green LED is lit.

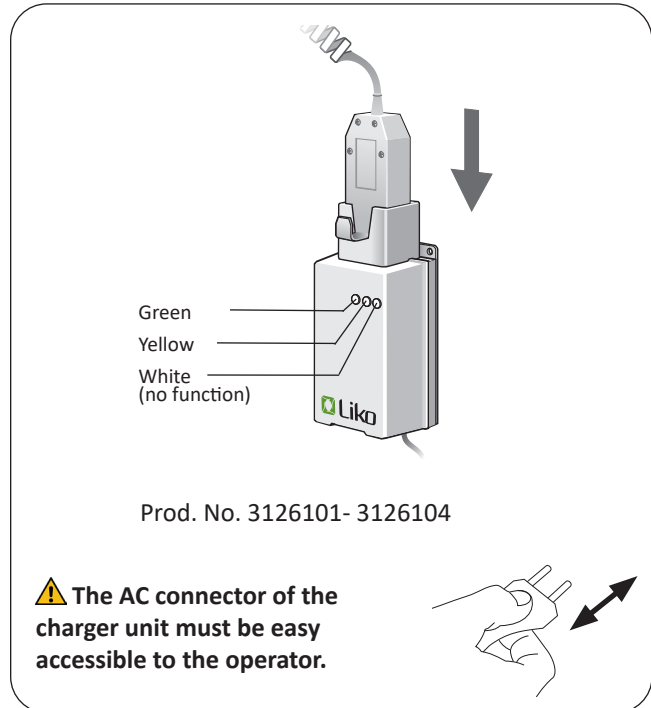

Alternative charging procedure

In-Rail Charging (IRC)

The Liko™ In-Rail Charging system is an easy to use charging system. When using the In-Rail Charging system the lift will charge continuously. During active lifting the In-Rail Charging system will "pause" and re-activate charging automatically after completed operation.

Indications from IRC:

- A green LED-light on the lift indicate that the lift is ready to use.
- A yellow LED-light on the lift indicate that the lift has low battery capacity, contact Hill-Rom if the problem persists.

For more information, please contact your Hill-Rom representative.

MultiStation

As an alternative to charging via the hand control, the batteries can be charged with a MultiStation installed on the rail system. In this case, Likoall overhead lift must be equipped with a contact rail or a transfer motor. The Likoall overhead lift batteries are then charged by parking the lift in the charging position under the MultiStation (see figure).

This charging procedure is also suitable when Likoall overhead lift is operated by HandControl IR.

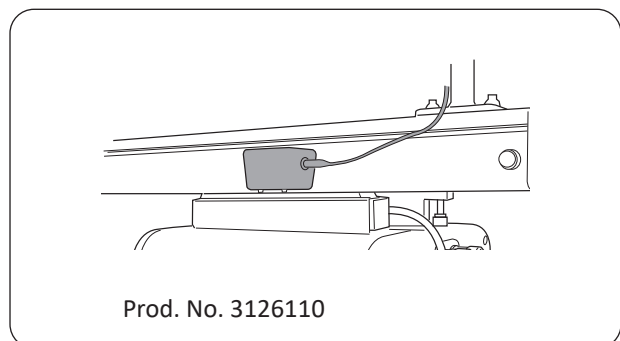

Transferring from Room to Room

The Liko™ R2R Room-to-Room system is an effective solution for safe transfer of patients between two or more rooms. The R2R system is mounted without making openings in walls over doors and full isolation is therefore retained between the rooms supported by the system.

The transfer is performed in a safe manner, with the aid of separate rail systems for each room. The Liko™ R2R system enables linking together two Likorall overhead lifts when transferring from room to room. The actual transfer operation between two rooms is performed with a comfortable transition for the patient from one Likorall overhead lift to another.

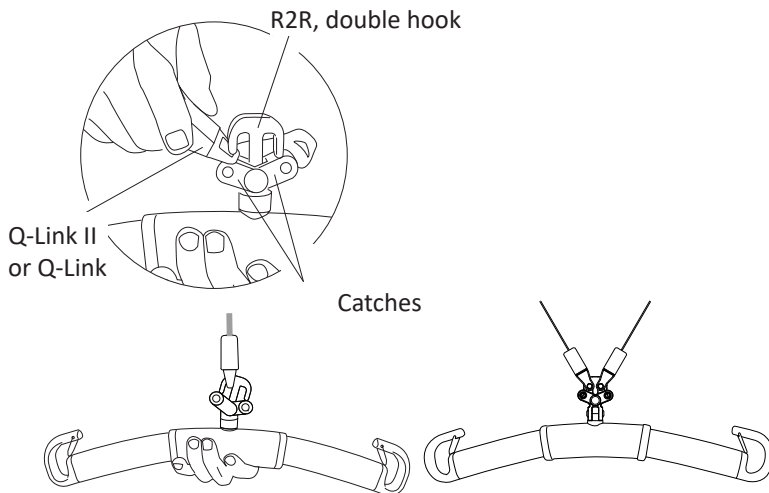

Mounting a Q-Link to the sling bar R2R

A sling bar R2R with double hook fits two Q-Links (whether Q-Link II or Q-Link). The two catches keep the Q-Link II or Q-Link in place in the R2R double hook before any load is applied to the lift strap. Open the catch gently when placing a Q-Link II or Q-Link in the R2R double hook.

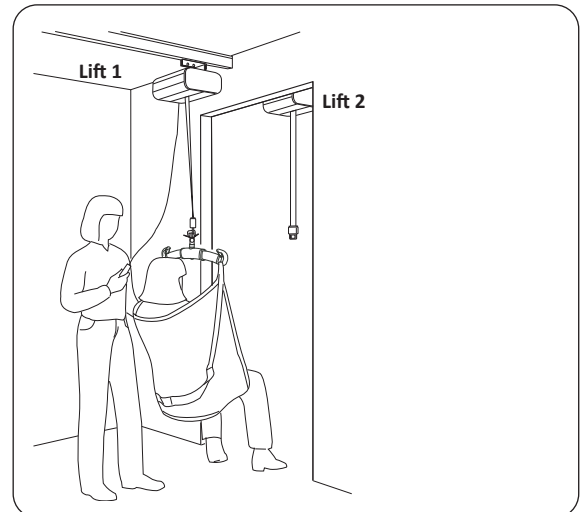

1. Move Lift 1 with the patient as close to the door way as possible. Lower the lift as far as possible, bearing in mind the patient's comfort.

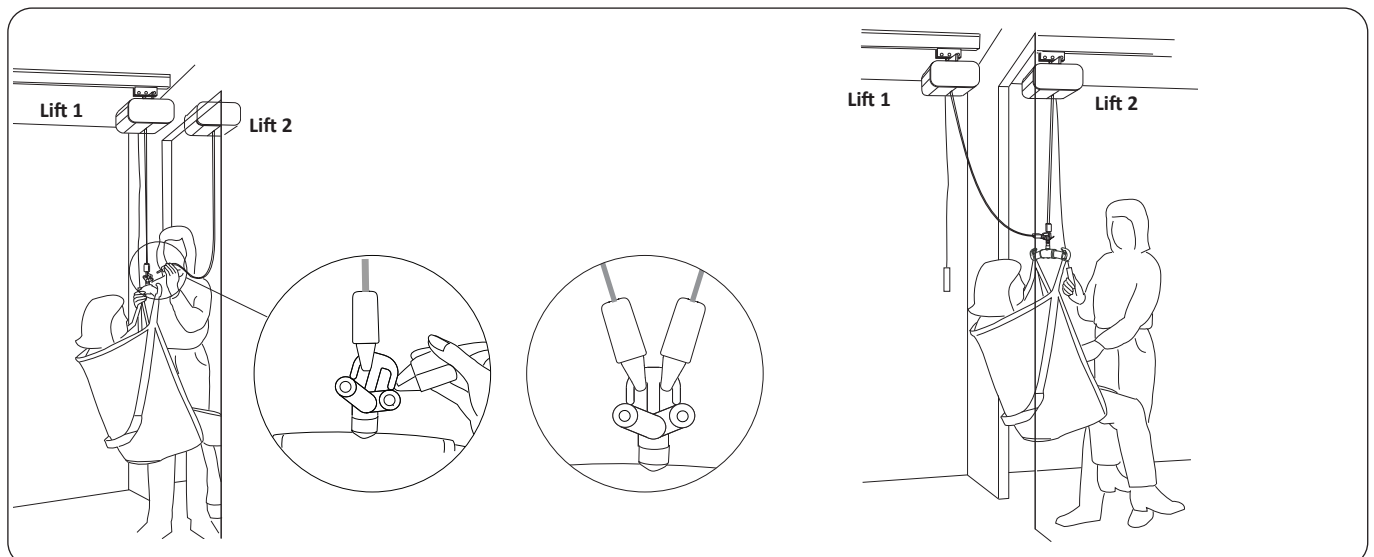

2. Move Lift 2 as close to the door opening as possible. Lower the lift strap from Lift 2 a sufficient length and connect the Q-Link II or Q-Link to the sling bar R2R. Check that the catches on the R2R double hook function properly.
NOTE! For transfer between multiple rooms a Carriage adjustable could be used instead of a lift motor.

3. Raise Lift 2. The patient is successively moved to the next room and finally suspended in Lift 2 only. When the pressure is relieved from the lift strap for Lift 1, disconnect the lift strap from the sling bar R2R and the transfer can be carried out in the next room.
NOTE! To free the Q-Link II or Q-Link from the sling bar R2R, it may be necessary to let out additional strap from Lift 1.

Maximum Load

Different maximum loads may apply to different products on the assembled lift system: lift, sling bar, sling and any other accessories used. For the assembled lift system, the maximum load is always the lowest maximum load rating for any of the components. For example, a Liko overhead lift that is approved for 200 kg (440 lbs) can be equipped with a lifting accessory which is approved for 300 kg (660 lbs). In this case, the maximum load of 200 kg (440 lbs) applies to the assembled lift system.

Study the markings on the lift and lifting accessories or contact your Hill-Rom representative if you have any questions.

Recommended Lifting Accessories

⚠ Using lifting accessories other than those approved can entail a risk.

Find generally recommended sling bars and accessories for Liko overhead lift described below. Some accessories may not currently be available.

For additional guidance in selecting a sling, study the instructions for Use for the respective sling models. There you will also find guidance for combining Liko™ sling bars with Liko™ slings. Contact your Hill-Rom representative for advice and information on the Liko™ product range.

Universal SlingBar 350 with Quick-release Hook

Fixed connection, prod. no. 3156074*
Max. load 300 kg (660 lbs)

Prod. No. 3156084



Universal SlingBar 450 with Quick-release Hook

Fixed connection, prod. no. 3156075*
Max. load 300 kg (660 lbs)

Prod. No. 3156085



Universal SlingBar 600 with Quick-release Hook

Fixed connection, prod. no. 3156076*
Max. load 300 kg (660 lbs)

Prod. No. 3156086

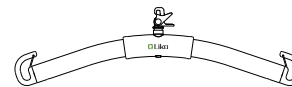

Universal SlingBar 670 Twin with Quick-release Hook

Fixed connection, prod. no. 3156077*
Max. load 300 kg (660 lbs)

Prod. No. 3156087

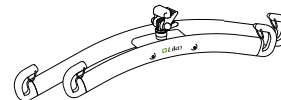

Universal SideBars 450 including bag

Max. load 300 kg (660 lbs)

Prod. No. 3156079

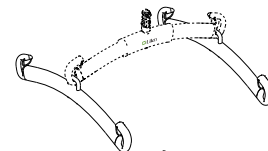

Sling Cross-bar 450 with Quick-release Hook

Fixed connection, prod. no. 3156021*
Max. load 300 kg (660 lbs)

Prod. No. 3156022

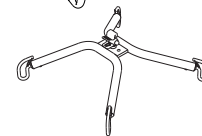

Sling Cross-bar 670 with Quick-release Hook

Fixed connection, prod. no. 3156018*
Max. load 300 kg (660 lbs)

Prod. No. 3156019

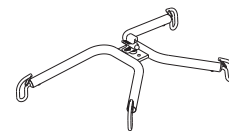

* Sling bars with fixed connection can be equipped with Quick-release Hook

Universal SlingBar 350 R2R

Max. load 300 kg (660 lbs)

Prod. No. 3156094

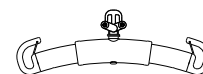

Universal SlingBar 450 R2R

Max. load 300 kg (660 lbs)

Prod. No. 3156095

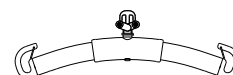

Carriage Adapter Liko for S65

Prod. no. 3126030



Carriage Adjustable

Carriage, adjustable 300-500 mm (12-20 in), R2R
Carriage, adjustable 500-900 mm (20-35 in), R2R
Carriage, adjustable 900-1300 mm (35-51 in), R2R

Prod. No. 3121660
Prod. No. 3121661
Prod. No. 3121662

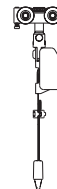

Quick-release Hook

The Liko™ Quick-release Hooks form a system providing safe and easy changing of lifting accessories. The Liko™ Quick-release Hooks protect against unintentional detachment. Likorall 200 overhead lift is used solely with lifting accessories equipped with Quick-release Hooks.

Quick-release Hook Universal fits Universal SlingBar 350, 450 and 600 (Prod. No. 3156074-3156076).

Quick-release Hook TDM fits Sling Cross-bar 450 and 670 (Prod. No. 3156021 and 3156018) and Universal TwinBar 670 (Prod. No. 3156077).

Contact your Hill-Rom representative for more information

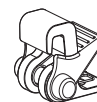

Quick-release Hook
Universal
Prod. No. 3156508



Quick-release Hook
TDM
Prod. No. 3156502

Stretcher

All stretchers in the Liko™ product range can be used with Likorall™ overhead lift.

Liko™ FlexoStretch

Prod. No. 3156057

Liko™ OctoStretch with Leveller

Prod. No. 3156056

Liko™ Stretch Mod 600 IC, wide

Prod. No. 3156065B.

Liko™ UltraStretch

Prod. No. 3156058

Contact your Hill-Rom representative for more information

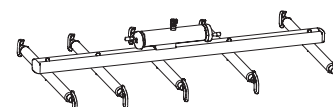

LikoScale™ device

for weighing a patient in combination with Likorall overhead lift.

LikoScale™ 350, Max 400 kg (880 lbs)

Prod. No. 3156228

LikoScale™ 350 is certified according to the European Directive NAWI 2014/31/EU (Non-Automatic Weighing Instruments).

LikoScale™ devices only for use in the United states and Canada:

LikoScale™ 200, Max. 200 kg (440 lbs.)

Prod. No. 3156225

LikoScale™ 400, Max. 400 kg (880 lbs.)

Prod. No. 3156226

Contact your Hill-Rom representative for more information.

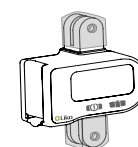

LikoScale 350
Prod. No. 3156228

SlingBar Cover Paddy 30

Fits Universal SlingBars 350, 450 and 600, as well as SlingBar Sling 350

Prod. no. 3607001



Hang-up HandControl Hanger

Sold in set of 10 pcs.

Prod. no. 3156100



Multi-Connector

Intended for installation on Likorall overhead lift for control of switches and/or if the rail system is equipped with a MultiStation for charging via the rail.

Prod. no. 3126111

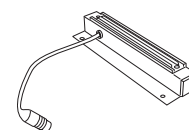

Transfer motor Likorall ES Overhead Lift

Fits Likorall overhead lift with ES designation
Max. 250 kg (550 lbs)

Prod. no. 3126044

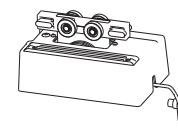

HandControl Remote IR

Likorall overhead lift with ES designation can be equipped with a wireless hand control (IR). The hand control operates normally within a range of 0-5 meters (0-196 inch.) from the lift.

Prod. no. 3126060

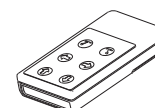

Parking Panel 600, LR/MR

Prod. no. 3126075

Parking Panel 1500, LR/MR

Prod. no. 3126080

Can be completed with the following accessories:

Hook for SlingBar

Prod. no. 3126070

Hook for Accessories

Prod. no. 3126071

Bracket for Charger

Prod. no. 3126100

Quick Reference Guide (see respective product)

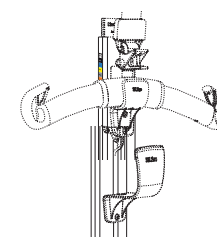

Troubleshooting

The lift doesn't work



1. Make sure that the emergency stop button has not been activated (shall not be pressed in).
2. Check that the handcontrol cable is connected correctly.
3. Charge the battery.
4. *If the problem persists, please contact Hill-Rom.*

A repeated signal can be heard from the lift



1. Charge the battery immediately.
2. *If the problem persists, please contact Hill-Rom.*

The lift is stuck in the high position



1. Make sure that the emergency stop button has not been activated (shall not be pressed in).
2. Check that the handcontrol cable is connected correctly.
3. Use the selected mechanical or electrical emergency lowering device to lower the patient onto a firm surface.
4. Charge the battery.
5. *If the problem persists, please contact Hill-Rom.*

The lift does not achieve maximum lifting capacity



1. Charge the battery.
2. *If the problem persists, please contact Hill-Rom.*

In event of unusual sounds or any leakage from the lift



Contact Hill-Rom.

Recycling Instructions

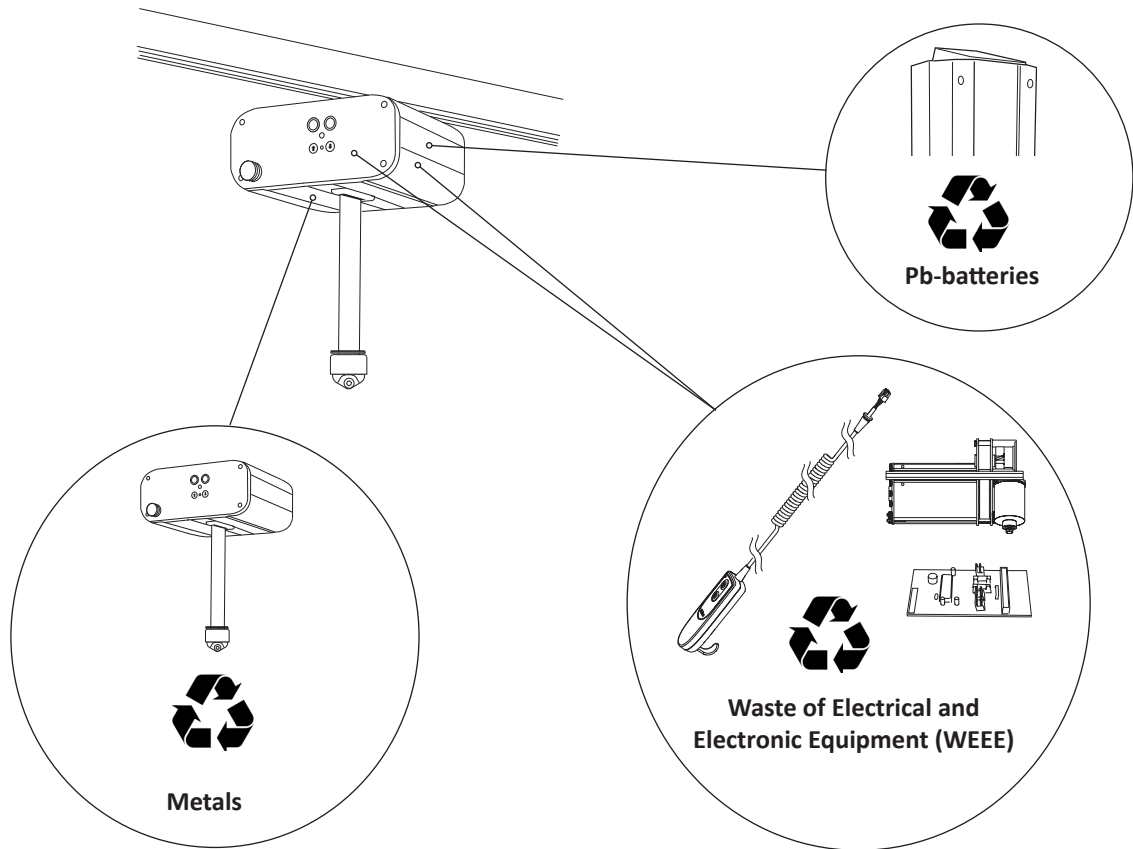

Old batteries are to be deposited at the nearest recycling station or given to personnel authorized by Hill-Rom. Likorall overhead lift comply with the Directive 2012/19/EEC on waste electrical and electronic equipment.

Hill-Rom evaluates and provides guidance to its users on the safe handling and disposal of its devices to aid in the prevention of injury, including, but not limited to: cuts, punctures of the skin, abrasions, and any required cleaning and disinfection of the medical device after use and prior to its disposal. Customers should adhere to all federal, state, regional, and/or local laws and regulations as it pertains to the safe disposal of medical devices and accessories.

If in doubt, the user of the device shall first contact Hill-Rom Technical Support for guidance on safe disposal protocols.

Cleaning and Disinfection

These instructions do not replace the facility's own cleaning and disinfection policies.

Warnings:

To help prevent injury and/or equipment damage, obey these warnings:

- Warning—The potential for electrical shock exists with electrical equipment. Failure to follow facility protocol could cause death or serious injury.
- Warning—Do not reuse wiping material for multiple steps or on multiple products.
- Warning—Harmful cleaning solutions may cause skin rash and/or irritation upon contact. Follow the manufacturer's instructions found on the product label and Safety Data Sheet (SDS).
- Warning—Lift and move items correctly. Do not twist, and seek assistance when necessary.
- Warning—Fluid spills on to the lift electronics could cause a hazard. If this happens do not put the lift back into service until it is completely dry, tested, and found to be safe to operate.

Cautions:

To help prevent equipment damage, obey these cautions:

- Caution—Do not steam clean or power wash the lift. Pressure and excessive moisture can damage the protective surfaces of the lift and its electrical components.
- Caution—Do not use harsh cleansers/detergents, heavy duty grease removers, solvents such as toluene, xylene, or acetone, and do not use scouring pads (you may use a soft bristle brush).
- Caution—Fully extend the lift strap prior to the cleaning and disinfection process.

Safety Recommendations

- Wear protective equipment according to manufacturer's instruction and per facility protocol throughout the cleaning operations, such as: gloves, eye protection, apron, face mask and shoe covers.
- Unplug mains (AC power source) before cleaning and disinfection.
- Never clean the lift by pouring water on it, steam cleaning it, or by using a high-pressure jet.
- Refer to the recommendations made by the cleaning and disinfecting product manufacturer.

Process Recommendations:

For proper cleaning and disinfection, staff members should be trained.

The trainer should carefully read the instructions and follow them when the trainee is being trained.

The trainee should:

- Be given time to read the instructions and to ask any questions.
- Clean and disinfect the product while the trainer supervises. During, and/or after this process, the trainer should correct the trainee about any differences from the instructions for use.

The trainer should supervise the trainee until the trainee can clean and disinfect the lift as instructed.

Hill-Rom recommends to clean and disinfect the lift between patient use and regularly during extended patient stays.

Some fluids used in the hospital environment, such as iodophor and zinc oxide creams, can cause permanent stains. Remove temporary stains by wiping vigorously with a lightly-dampened wiping cloth.

Cleaning and Disinfection Overview:

Cleaning and disinfection are distinctly different processes. **Cleaning** is the physical removal of visible and non-visible soil and contaminants. **Disinfection** is intended to kill microorganisms.

When you perform the detailed cleaning steps, please note the following:

- A microfiber cloth is recommended as the wiping cloth.
- A soft bristle brush is recommended as a cleaning tool for the small holes in the Q-Link II.
- Always replace the wiping cloth when visibly soiled.
- Always replace the wiping cloth between steps (spot clean, clean, and disinfect)
- Always use Personal Protective Equipment (PPE) such as gloves, eye protection, apron, face mask, and shoe covers, as recommended by the facility protocol and manufacturers instructions



Cleaning and Disinfection Equipment:

- Protective equipment (such as: gloves, eye protection, apron, face mask and shoe covers) as recommended by the facility protocol and manufacturers instructions
- Disposable microfiber cloths recommended
- Soft bristle brush
- Warm water
- To find Cleaning / Disinfectants compatible or not compatible for use on Liko™ products, follow the "Application of commonly used Cleaning / Disinfectants on Liko products" in this document.

Prepare the Unit for Cleaning and Disinfecting:

1. ⚠️ **Unplug mains (AC power source) before cleaning and disinfection.**
2. Fully extend the lift strap by using the emergency lowering.

Likorall overhead lift with mechanical emergency lowering: fully extend the lift strap by using the mechanical emergency lowering. After cleaning the lift strap and before you raise the sling bar, make sure the lift strap has dried. After the mechanical emergency lowering device is used, the lifting level needs to be restored; see the Instructions for use for the Likorall overhead lift.

Step 1: Cleaning

1. Unplug the mains (AC power source) before cleaning and disinfection.
2. As necessary, first remove visible soil from the lift with a cloth moistened with warm water and a neutral, approved cleaner/disinfectant. See "Application of commonly used Cleaning / Disinfectants on Liko products." Do not use a cloth that is dripping wet.
 - A soft bristle brush may be used for hard-to-clean areas to remove stains and resistant dirt and to loosen hardened soil.
 - Use as many wiping cloths as needed to remove the soil. Replace cloth when soiled.
 - After cleaning the lift strap, make sure it is dry.
3. Wipe down the entire lift starting from the top down. Give special attention to seams, cracks and other areas where soil may accumulate. In particular, pay special attention to the following areas:

- Lift strap
- Electrical emergency lowering/raising
- Emergency stop
- Emergency stop cord
- Mechanical emergency lowering (where applicable)
- Sling bar
- Hand control

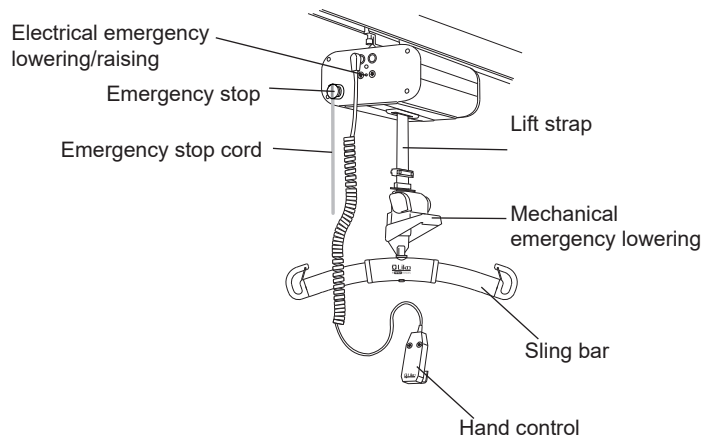

Cleaner/Disinfection:

NOTE:

It is important to remove all visible soil from all areas before continuing to remove non-visible soil.

With a new wiping cloth soaked in an approved cleaner/disinfectant, use firm pressure to wipe all surfaces of the lift. Use a new or clean wiping cloth as often as necessary. Make sure the following items are cleaned:

- Hand Control
- Sling (refer to the specific sling Instructions for use and 7EN160884 Care and Maintenance of Liko Slings)
- Lift Motor
- Slingbar
- Any part of the rail that may be soiled
- Lift Strap
- Scale (if applicable)
- Power cord
- Connection points

Damaged items should be replaced!



Step 2: Disinfection:

1. For the use of suitable disinfectants see "Application of commonly used Cleaning / Disinfectants on Liko products" in this document.
2. Follow the manufacturer's instructions.
3. Make sure all surfaces **remain wet with the cleaner/disinfectant** for the **specified contact time**. Rewet surfaces with a new wiping cloth as necessary and per the manufacturer's instructions.

NOTE:

If bleach is used with another cleaner/disinfectant, use a new or clean cloth/wipe soaked in tap water to remove any disinfectant residue prior to and after the bleach application.

 **The lift may not be cleaned with CSI or equivalent.**

 **The hand control may not be cleaned with Viraguard or equivalent.**

 **The lift strap may not be cleaned with Oxivir Tb, Dispatch, Chlor-Clean, Dismozon Pur or equivalent.**

Application of commonly used Cleaning / Disinfectants on Liko™ products

Chemical class	Active ingredient	pH	Cleaners / Disinfectant *)	Manufacturer *)	May not be used on the following items:
Quaternary ammonium chloride	Didecyl dimethyl ammonium chloride = 8.704% Alkyl dimethyl benzyl ammonium chloride = 8.19%	9.0 – 10.0 in use	Virex II (256)	Johnson/Diversey	Foot rest for Sabina™ and Roll-On™
Quaternary ammonium chloride	Alkyl dimethyl benzyl ammonium chloride = 13.238% Alkyl dimethyl ethylbenzyl ammonium chloride = 13.238%	9.5 in use	HB Quat 25L	3M	
Accelerated Hydrogen Peroxide	Hydrogen Peroxide 0.1 – 1.5% Benzyl Alcohol: 1-5% Hydrogen Peroxide 0.1 – 1.5% Benzyl Alcohol: 1-5%	3	Oxivir Tb	Johnson/Diversey	The lift straps for Golvo™ and ceiling lifts
Phenolic	Ortho-Phenylphenol = 3.40% Ortho-Benzyl-para-Chlorophenol = 3.03	3.1 +/- 0.4 in use	Wexcide	Wexford Labs	
Bleach	Sodium hypochlorite	12.2	Dispatch	Caltech	The lift straps for Golvo™ and ceiling lifts
Alcohol	Isopropyl alcohol = 70%	5.0 – 7.0	Viraguard	Veridien	Hand controls for all lifts
Quaternary ammonium	n-Alkyl dimethyl benzyl ammonium chlorides = 0.105% n-Alkyl dimethyl ethylbenzyl ammonium chlorides = 0.105%	11.5 - 12.5	CSI	Central Solutions Inc.	Viking™, Liko M220™, Liko M230™, Uno™, Sabina™, Golvo™, LikoLight™, Roll-On™, LikoRall™, Multirall™
Benzyl-C12-18-alkyldimethylammonium, chlorides	Benzyl-C12-18-alkyldimethylammonium, chlorides (22 %) 2-Phenoxyethanol (20 %) Tridecylpolyethylenglycolether (15 %) Propan-2-ol (8 %)	approx 8.6 in use	Terralin Protect	Shülke	Foot rest for Sabina™ and Roll-On™
Organic peroxide (type E, solid)	Magnesium monoperoxyphthalate hexahydrate (50-100%) Anionic surfactant (5-10%) Nonionic surfactant (1-5%)	5.3 in use	Dismozon Pur	Bode	The lift straps for Golvo™ and ceiling lifts
Ethanol	Hydrogen peroxide (2.5-10 %) Lauryl dimethylamine oxid (0-2.5 %) Ethanol (2.5-10 %)	7	Anioxy-Spray WS	Anios	Control box for all mobile lifts
Trolosene sodium	Adipic acid 10-30% Amorphous silica < 1% Sodium Toluene sulphionate 5-10 % Trolosene sodium 10-30 %	4-6 in use	Chlor-Clean	Guest Medical Ltd	The lift straps for Golvo™ and ceiling lifts

*) Or equivalent

Inspection and Maintenance

For trouble-free use, certain details should be checked each day the lift is used:

- Inspect the lift and check to make sure that there is no external damage.
- Check the sling bar attachment.
- Check the lift strap for wear and to ensure the strap is not twisted.
- Check the functionality of the latches.
- Check the operation of the lift movement.
- Check to make sure that the emergency lowering functions correctly.
- Check that the mechanical emergency lowering functions and that the lifting height is set correctly.
- Charge the batteries each day the lift is used and then check that the charger works.

Clean the lift with a moist cloth. Find more detailed information regarding cleaning and disinfection of your Liko™ product in the chapter “*Cleaning and Disinfection*”.

⚠ The lift should not be exposed to running water.

Service

A periodic inspection of the lift should be carried out at least once per year.

⚠ Periodic inspection, repair and maintenance should be performed only in accordance with the Liko™ Service Manual and by personnel authorized by Hill Rom and using original Liko™ spare parts.

⚠ Service activities are not allowed with the patient in the lift.

Service Agreement

Hill-Rom offers the opportunity to enter into service contracts for the maintenance and regular inspection of your Liko™ product.

Expected Life Time

The product has an expected service life of 10 years when correctly handled, serviced and periodically inspected in accordance with Liko instructions.

Parts listed below are subject to wear and tear and have specific expected life time:

- Handcontrol, expected life time 2 years,
- Battery, expected life time 3 years.
- Liftstrap, expected life time 5 years.

Transport and Storage

During transportation, or when the lift is not to be used for a long time, the emergency stop should be activated. The environment where the lift is transported and stored should have a temperature of -10°C to +50°C (14°F–122°F) and a relative humidity of 20 to 90%. The atmospheric pressure should be 700–1060 hPa.

Product Changes

Liko™ products undergo continuous development, which is why we reserve the right to make product changes without prior notice. Contact your Hill-Rom representative for advice and information about product upgrades.

Design and Quality by Liko™ in Sweden

Liko is quality certified according to ISO 9001 and its equivalence for the medical device industry, ISO 13485. Liko is also certified according to environmental standard ISO 14001.

Notice to Users and/or Patients in EU

Any serious incident that has occurred in relation to the device, should be reported to the manufacturer and the competent authority of the Member State in which the user and/or patient is established.



www.hillrom.com

Liko AB,
Nedre vägen 100
975 92 Luleå, Sweden
+46 (0)920 474700

Liko AB is a subsidiary of Hill-Rom Holdings inc.

Enhancing outcomes for
patients and their caregivers:

Hill-Rom