

Product Description

The Liko ComfortVest is unique in safety, design, and function. The ComfortVest supports behind the patient's back and outside of the arms. The inner surface of the vest is covered with material which helps prevent the vest from sliding up on the body. The Liko ComfortVest is available in different sizes.

A waist belt is sewn to the vest to help keep the vest in place. This safety feature also helps avoid the risk of a patient sliding out of the sit-to-stand vest. You must use a combination of two loops on each hook when attaching the vest to the lift.

The ComfortVest should be used with the Sabina sit-to-stand lift with Comfort SlingBar (600 mm / 23.6 inch. wide).

△ "Caution!" triangles are used to warn of situations that demand extra care and attention.

In this document, the person being lifted is referred to as the "patient" and the person helping them is referred to as the "caregiver".

 **Read the instruction guide for both the sling and the lift being used. Instruction guides can be downloaded, free of charge, at www.liko.com.**

Description: Liko ComfortVest

1. Outer vest
2. Serial number
3. Size label (color)
4. Product label
5. Label:
Periodic Inspection
6. Label:
Individual marking (Belongs to)
7. Outer strap
8. Inner strap
9. Loop strap
10. Lower edge
11. Waist belt
12. Inner strap guide
13. D-ring
14. Outer strap guide

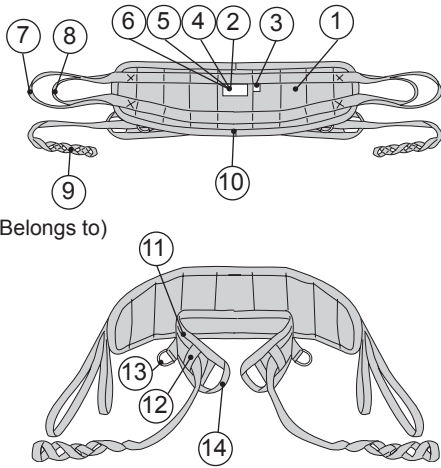

⚠ Before lifting, remember the following:

- The need for one or more caregivers must be determined from case to case.
- Plan the lift carefully to ensure that it is performed as safely and conveniently as possible.
- Although Liko's slingbars are equipped with safety latches, particular care must be taken. Before the patient is lifted from the underlying surface, but after the straps have been fully extended, make sure the straps are properly hooked to the slingbar.
- Never lift a patient higher above the underlying surface than is necessary for the lifting and transfer procedure.
- Never leave a patient unattended during a lifting situation.
- Make sure the wheels on the bed, gurney, etc. are locked during the lifting/transfer operation.

Description: Using the Straps

A: Outer vest straps

For maximum flexibility, the outer vest is equipped with two sets of straps, i.e., the outer straps and the inner straps. Generally, you would use the inner straps to help the patient achieve a maximum upright stance. The outer straps are needed when a patient's girth requires it, or if a patient is short in relation to the height of the slingbar hooks on a Sabina. In cases where you use the inner straps we recommend that you also hook the outer straps to the lift to have better visual control of the straps.

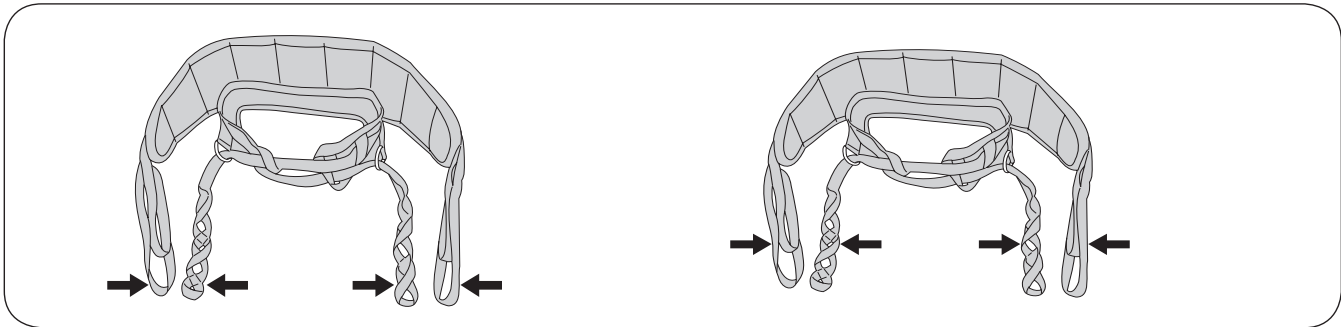

A:1 When you attach the outer straps (outer vest), the distance between the patient and the lift is greater, and the patient is not lifted as high.

A:2 When you attach the inner straps (outer vest) there is less distance between the patient and the lift, and the patient is lifted higher.

B: Loop straps

The loop straps are used to adjust the fit of the vest around the upper body, depending on which of the loops you attach to the Sabina hooks. The straps can be lengthened with Liko Extension Loops in case they are too short for a patient.

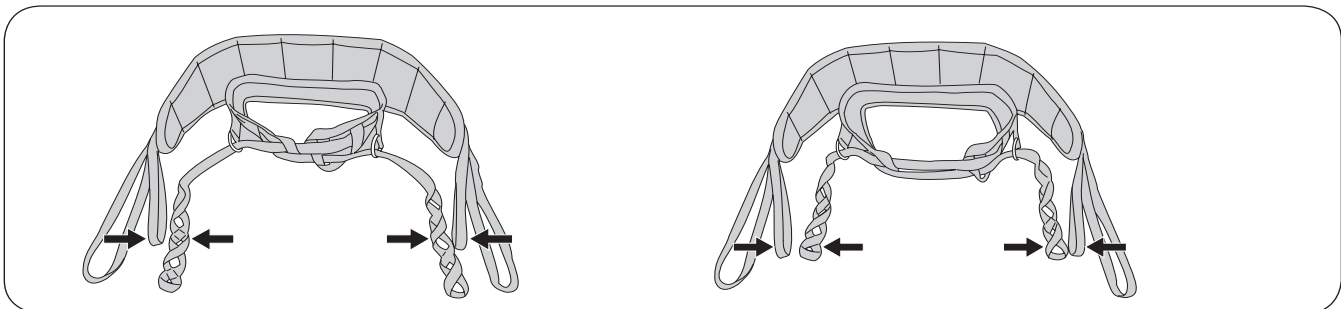

B:1 Use the inner loops for a tighter fit.

B:2 Use the outer loops for a looser fit.

During a sit-to-stand lift, the vest will tighten around the body only as long as the outer vest's straps are slack. As tension increases on the outer vest's straps, it takes tension off of the loop straps so the waist belt does not tighten further.

Loop Clips

This practical accessory is used to mark the loops that have been tried out for a certain person. It makes it easier for the caregiver to choose the right loop to attach to the slingbar.

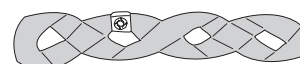

Fitting the ComfortVest

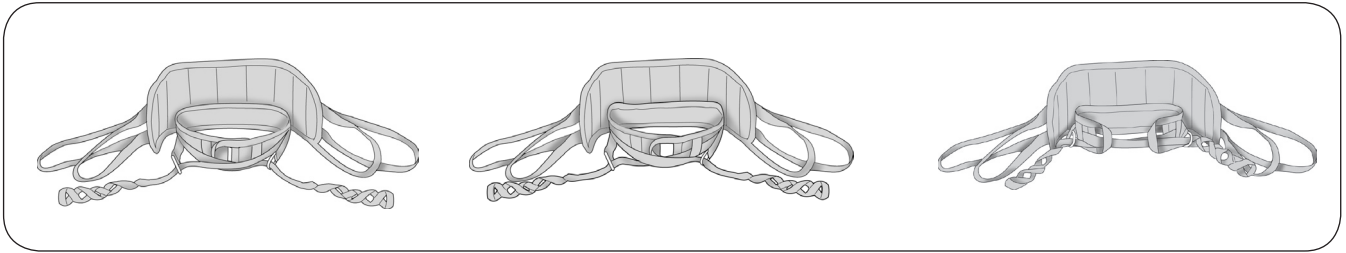

Alt A: For very thin patients.
Remove the loop straps from the inner strap guides before threading them through the metal D-rings. This creates the tightest fit.

Alt B: Average patients.
Remove only one of the loop straps from an inner strap guide. Then cross the loop straps and thread them through the metal D-rings.

Alt C: For large patients.
Thread the loop straps through both the inner and both outer strap guides before threading them through the metal D-rings.

Active standup lifting with Sabina and Liko ComfortVest

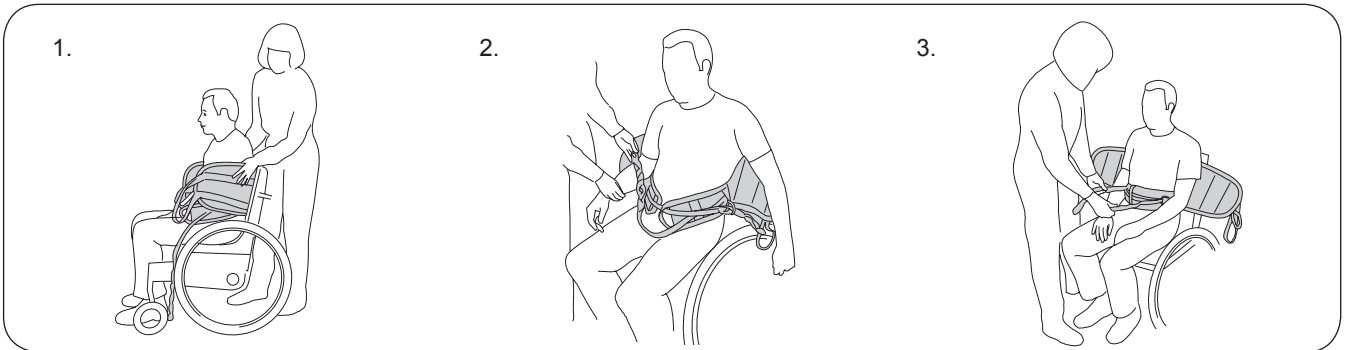

1. Slide the ComfortVest down behind the patient to waist level. The lower edge of the waist belt should be farthest down and placed closest to the body with the patient's arms between the vest and the waist belt.

2. Cross the loop straps and thread them through the D-rings on the opposite sides. See description above for different fitting alternatives.

3. Pull on the loop straps to check that the belt tightens. If the waist belt does not tighten sufficiently, change the threading of the loop straps.

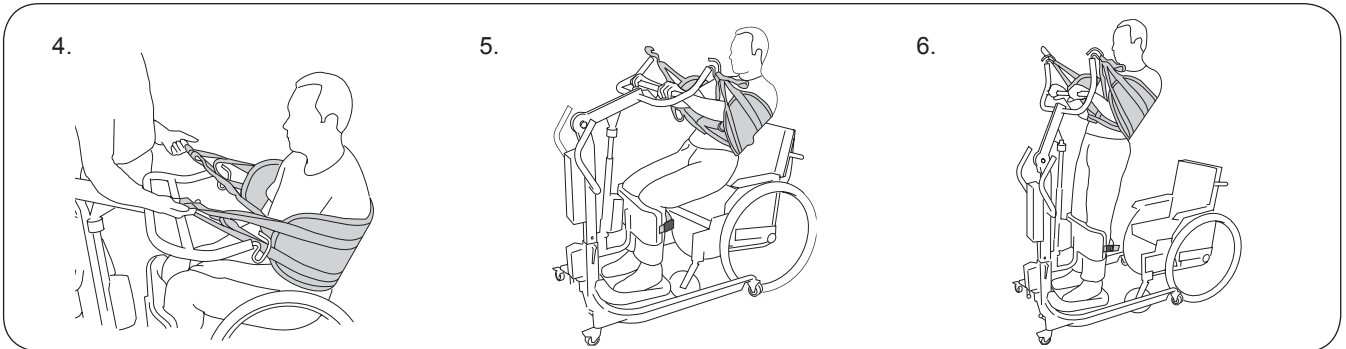

4. Determine which of the straps (outer or inner) should be hooked to the lift by pulling diagonally upward and outward on the outer vest straps and the loop straps simultaneously.

See diagram of straps on page 2, B: Loop straps.

Fit the belt around the abdomen by using a configuration which keeps equal tension on the outer vest's straps and the loop straps as they tighten while the patient stands.

Put Sabina in place and adjust the width of the base. Place the patient's feet centered on the foot rest. The lower legs (below the knees) should be parallel to the lower leg pad on the lift. Adjust the horizontal and vertical position of the pad if necessary. Attach and tighten the strap around the lower legs.

Now it is time to attach the loop straps and outer vest's straps to the hooks on the lift (using the loops you selected according to the instruction above).

5. Standing. Maneuver the lift by pressing on the up and down buttons of the hand control (two speeds possible). The patient can actively participate by holding the crossbar and pulling himself/herself up.

Hint! We recommend that patients lean back with their upper body during lifting to compensate for weak muscles in the lower body. This helps patients stand, enhances comfort, and prevents the vest from sliding upward.

6. The height a patient is lifted should be determined from case to case. Regulating the maximum standup height can be done by:

- Adjusting the Sabina base for the lifting height. See the instruction guide for your Sabina lift.
- Selecting between the inner or the outer straps on the outer vest. See page 2, A: Outer vest straps.

Facts About Liko ComfortVest, Mod. 95

Description	Prod. no.	Size	Body Weight*
Liko ComfortVest	3595414	Small	< 60 kg (130 lbs.)
Liko ComfortVest	3595415	Medium	50-80 kg (110-175 lbs.)
Liko ComfortVest	3595416	Large	70-110 kg (155-240 lbs.)
Liko ComfortVest	3595417	Extra Large	> 100 kg (220 lbs.)

* Caution! The weights given are approximate guides. Variations are possible.

Liko slings are approved for 200 kg (440 lbs.) maximum load or more. See product label.

Measures (cm)	A	B	C	D	E
Small	90	80	155	220	55
Medium	90	80	155	220	70
Large	110	105	180	240	85
Extra Large	110	120	180	240	100

Measures (in.)	A	B	C	D	E
Small	35	31	61	87	22
Medium	35	31	61	87	28
Large	43	41	71	94	34
Extra Large	43	47	71	94	40

The measures given are approximate guides - deviations may occur.

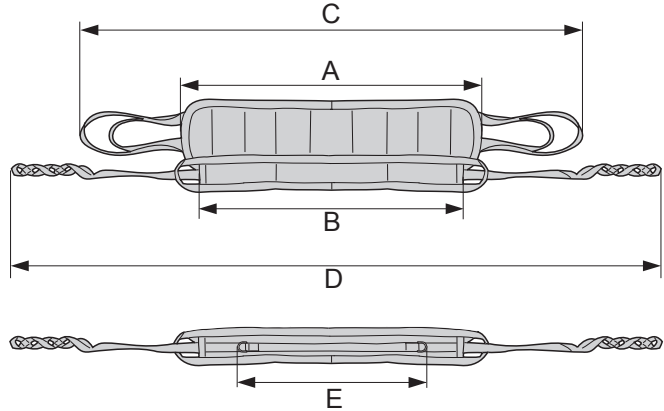

Washing instructions: See the sling's product label.

Expected Life Time

The product has an expected life time of 1-5 years with normal use. Expected life time varies depending on the fabric, use frequency, washing procedure, and weight carried.

Periodic Inspection

The product must be inspected at least once every 6 months. More frequent inspections might be required if the product is used or washed more often than normal. See Liko's protocol for Periodic Inspection for the respective product.

Combinations

The ComfortVest is intended for use only with Liko Sabina sit-to-stand lifts (different models available). We recommend Sabina with Comfort SlingBar (600 mm / 23.6 inch. wide).

Combinations of accessories/products other than those recommended by Liko can result in risks for the safety of the patient. In those cases where another manufacturer recommends Liko's accessories/products in combination with their or others' accessories/products, and the combinations are not approved by Liko, that manufacturer assumes the responsibility for that combination. Liko then refers to the responsible manufacturer's instruction guides and recommendations concerning usage, maintenance, cleaning, checking and inspection of the combination in order to fulfil the EN ISO 10535 requirements.

CE Class I medical device

Liko's products are constantly being updated and refined. Liko reserve the right to change aspects of the products without prior notice. Contact your local Liko representative for updated information and advice.

⚠ Caution!

Lifting and transferring a fellow human being always involves some risk. Therefore, it is essential to thoroughly study the instruction guides for both the lifts and the lifting accessories. Only staff members who are well versed in these instructions should use the equipment. Make certain that all slings and accessories are designed for the lift being used. Exercise caution and care when using all lifting products.

As a caregiver, you are always responsible for the patient's safety, and you must be aware of the patient's capacity in each lifting/transfer situation.

Check the slings regularly, particularly after laundering. Check for wear and damage to seams, fabric, straps, and strap loops. Never use damaged accessories. If you have any questions contact the manufacturer/supplier.



A Hill-Rom Company

www.liko.com

Manufacturer:

Liko AB
SE-975 92 Luleå
Sweden
info@liko.se

